

Direct type High-Speed Linear Servo Valves

Direct type high speed linear servo valves use a compact and powerful linear motor as an actuator and have an extremely simple structure that connects the linear motor moving coil, the spool, and the position sensor in series.

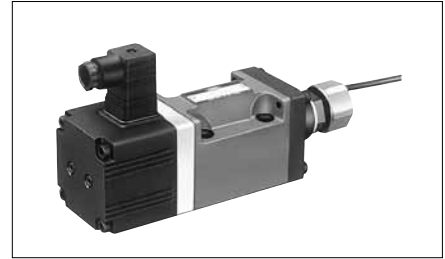

- **High accuracy**

These valves have a low hysteresis of 0.1 % or less, achieving high accuracy. They allow the main unit to operate with much higher repeatability.

- **High response characteristics**

The valves provide significantly high levels of step and frequency responses, which are typically used as measures of response characteristics; the step response is 2 ms (0 <=> 100 %)★, and the frequency response is 450 Hz/-90° (±25 % amplitude)★. Thus, the valves ensure that the main unit can achieve unprecedented high response.

(★: Representative values)

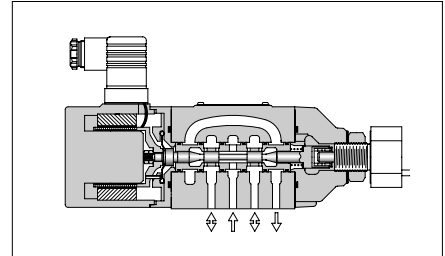

- **Excellent vibration-proof characteristics**

With a simple structure, the valves offer high vibration resistance.

- **Excellent contamination resistance**

The valves are also featured by excellent contamination resistance since they have a simple structure that directly connects the linear motor moving coil, the spool, and the position sensor. Compared to conventional servo valves for which the permissible contamination level is up to NAS 1638 class 7, the direct type linear servo valves can accept a contamination level of up to NAS 1638 class 10. These valves can contribute to greatly reducing the cost of fluid management.

Graphic Symbols

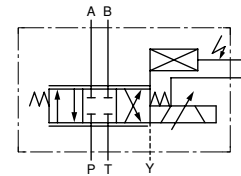

Model Number Designation

F—	LSVG	—03	—40	—R	—10
Fluid Type	Series Number	Valve Size	Rated Flow @ ΔP = 7 MPa	Cable Departure Direction	Design Number
F : Special Seals for Phosphate Ester Type Fluid (Omit if not required)	LSVG : Direct Type High Speed Linear Servo Valves	03	4 : 4 L/min 10 : 10 L/min 20 : 20 L/min 40 : 40 L/min 60 : 60 L/min	(Viewed from the linear motor side) None : Upper (Standard) R : Right L : Left	10

Exclusive Amplifiers

To ensure stable performance, it is recommended to use Yuken's AMLS series linear servo amplifiers.

Valve Model Number	Amplifier Model
LSVG-03-4/10/20/40	AMLS-A-D*-* -10
LSVG-03-60	AMLS-B-D*-* -10

Attachment

Mounting Bolt	Bolt Tightening Torque
Hex. Soc. Head Cap Screw: M8×65L···4 Pieces	30.8 - 37.7 Nm

Specifications

The specifications below are for use with a 48 V DC type exclusive amplifier; for use with a 24 V DC type amplifier, see the values in parentheses ().

Description		Model Numbers	
		LSVG-03-4/10/20/40	LSVG-03-60
Rated Flow @ $\Delta P = 7 \text{ MPa}$ ⁽¹⁾	L/min	4, 10, 20, 40	60
Max. Operating Pressure	MPa	35	
Proof Pres. at Return Port	MPa	35	
Drain Port (Y Port) Permissible Back Pres. ⁽²⁾	MPa	0.05	
Internal Leakage (PS = 14 MPa) (Viscosity: 32 mm ² /s)	L/min	1.7 or less	
Hysteresis	%	0.1 or less	
Step Response (0 <=> 100 %, Typical) ⁽³⁾	ms	2 (3)	3 (4)
Frequency Response (± 25 % Amplitude, Typical) ⁽³⁾	Gain: -3 dB	Hz	350 (300)
	Phase: -90°	Hz	450 (370)
Vibration Proof ⁽⁴⁾		Frequency: 10 - 60 Hz, Amplitude: 4 mm, Acceleration: 7.8 - 282 m/s ² Frequency: 61 - 2000 Hz, Amplitude: 4 - 0.0038 mm, Acceleration: 294 m/s ²	
Protection		IP 64	
Ambient Temperature	°C	-15 - +60	
Spool Type		Neutral/Zero Lap	
Spool Stroke to Stops	mm	± 0.5	± 0.75
Polarity		See the description about I/O signal characteristics on page 18.	
Linear Motor Specification	Current	A	2 [Max. 6]
	Coil Resistance	Ω	4.5 [at 20 °C]
Mass	kg	5	

Note: ⁽¹⁾ Use the valves so that the relationship between the valve pressure difference and the flow rate, as specified below in "Range of Flow Control", is met.

⁽²⁾ Back pressure at the drain port (Y) should be 0.05 MPa or less and not be a negative pressure.

⁽³⁾ This value is measured for each valve; it may vary depending on the actual circuit.

⁽⁴⁾ There are restrictions on the mounting position; refer to the instructions for details.

Range of Flow Control

Control Method: 4-Way Valve

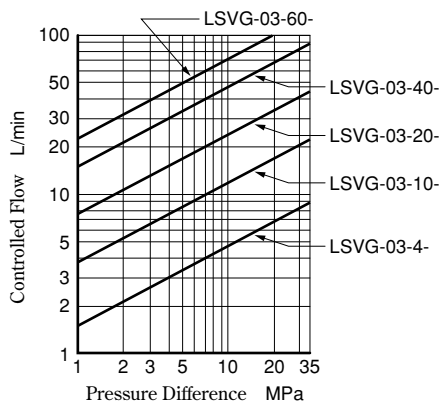
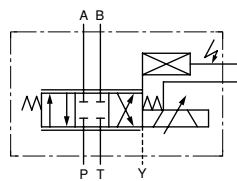

Control Method: 3-Way Valve

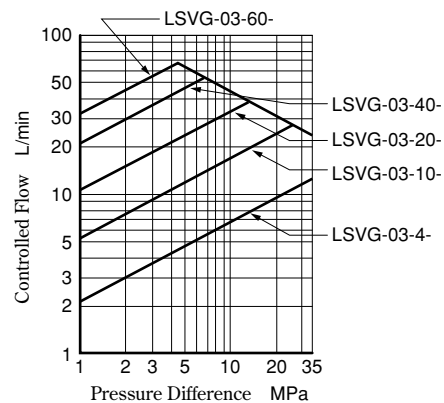
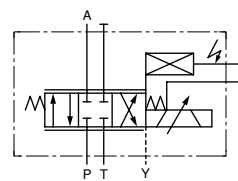

LSVG-03

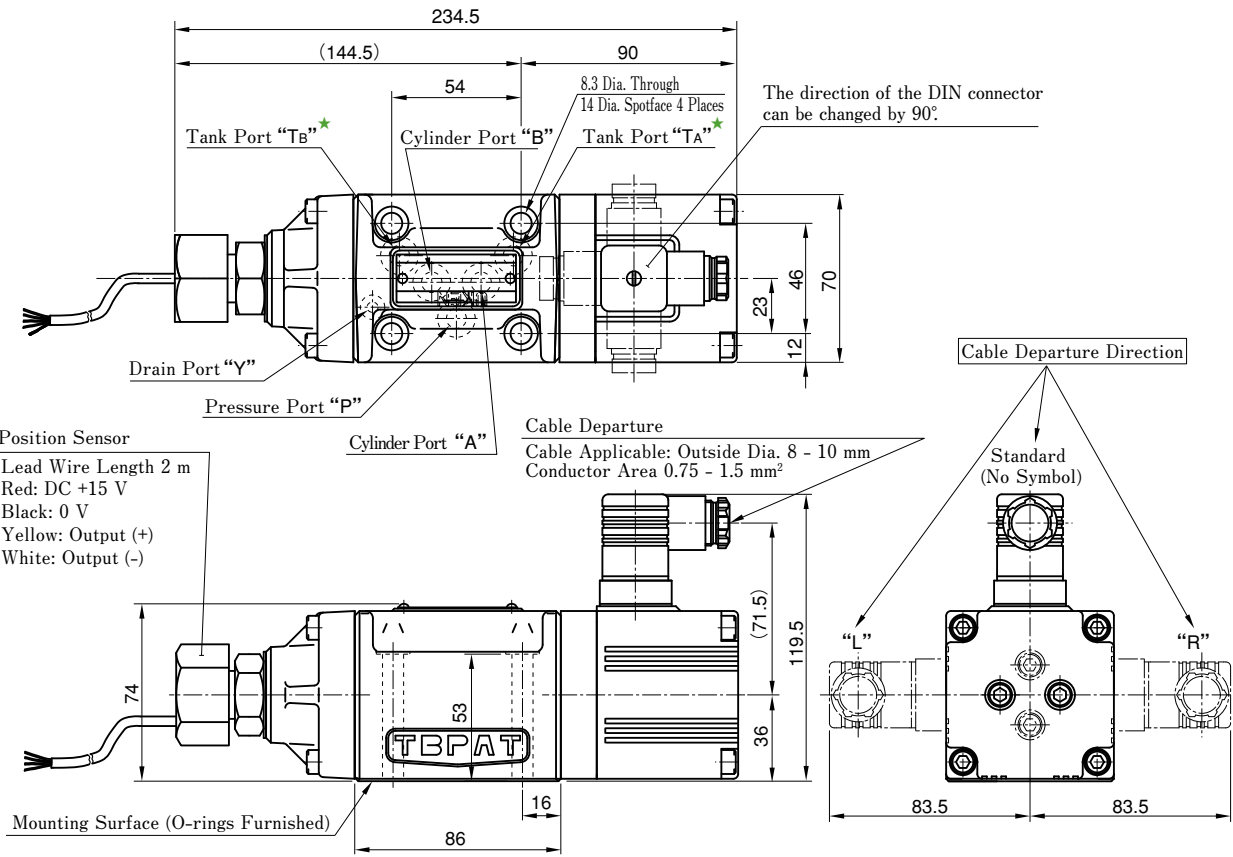

Note) Refer to the wiring diagram on page 20 for detailed connection between the DIN connector/position sensor and the amplifier.

● O-rings for the Ports

Port	O-ring Size	Qty.
P, A, B, T	AS568-014 (NBR,Hs90)	5
Y	JIS B2401-1B-P7	1

O-rings made of fluorinated rubber are required to use phosphate ester type fluids.

【Mounting Surface】

Prepare a mounting surface shown on the right. Basically, the dimensions of the mounting surface conform to the ISO standard, but the specifications for valve mounting screws are different as follows.

Consult us for valves available with M6 mounting screws.

	ISO 4401-05-04-0-94	Mounting Surface for LSVG-03
Valve Mounting Screw	M6	M8

The mounting surface should have a good machined finish.

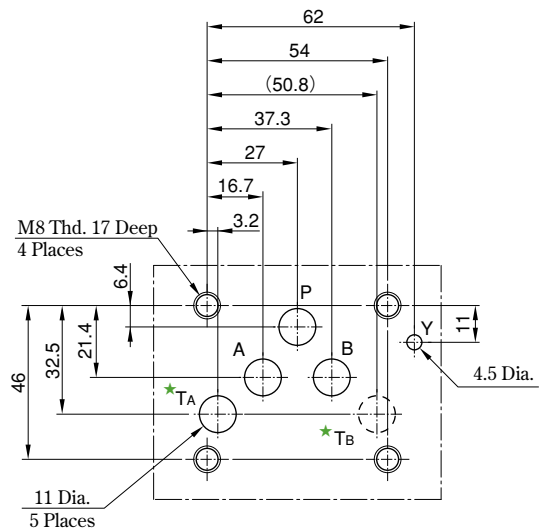

★ There are two tank ports "TA" and "TB"; however, "TA" may be used alone.

Characteristics of LSVG-03-4/10/20/40/60 (Fluid Viscosity: 30 mm²/s)

No-Load Flow Characteristics

<Conditions>

● Valve Pressure Difference : 7 MPa

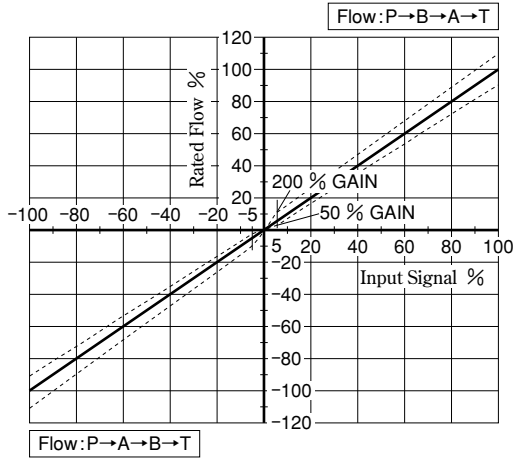

Load Flow Characteristics

<Conditions>

● Input Signal : 100 %

Note) Tolerance for Load Flow : ±10 %

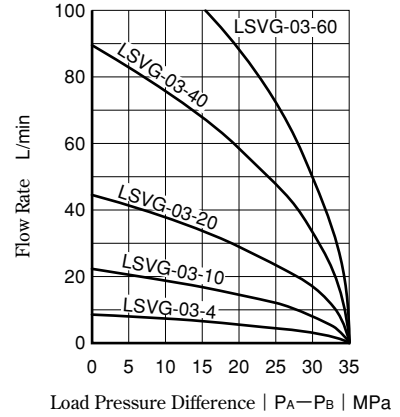

Step Response

<Conditions>

● Input Amplitude : 0 ⇔ 100 % ● Supply Pressure : 14 MPa

● LSVG-03-4/10/20/40-10

Amplifier : AMLS-A-D48- * -10 (Power Supply: 48 V DC)

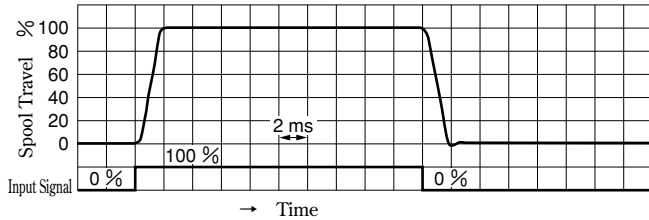

● LSVG-03-60-10

Amplifier : AMLS-B-D48- * -10 (Power Supply: 48 V DC)

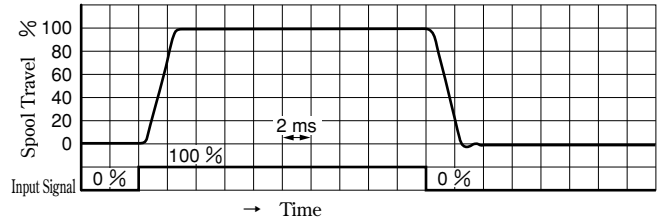

Amplifier : AMLS-A-D24- * -10 (Power Supply: 24 V DC)

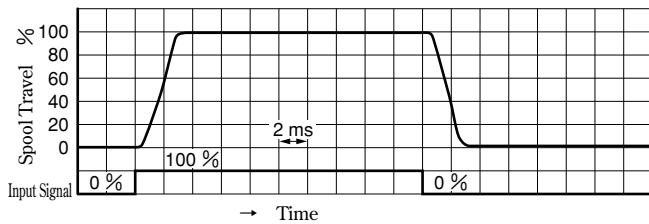

Amplifier : AMLS-B-D24- * -10 (Power Supply: 24 V DC)

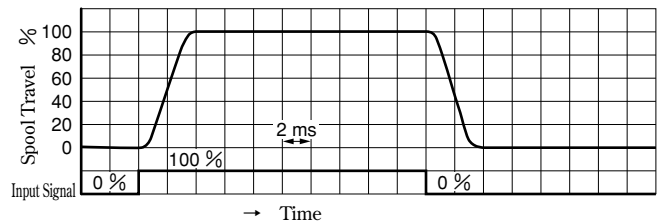

Frequency Response

<Conditions>

● Hydraulic Circuit: Port A/B Closed ● Supply Pressure : 14 MPa

● LSVG-03-4/10/20/40-10

Amplifier : AMLS-A-D48- * -10 (Power Supply: 48 V DC)
Input Signal $\pm 25\%$

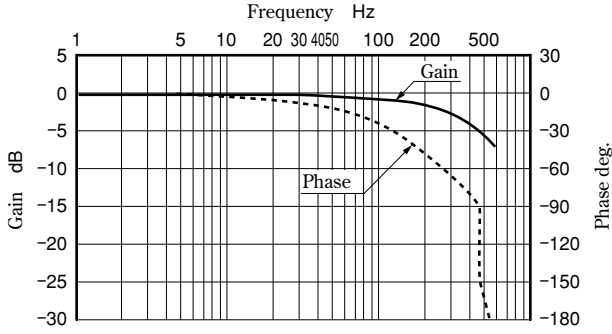

Input Signal $\pm 100\%$

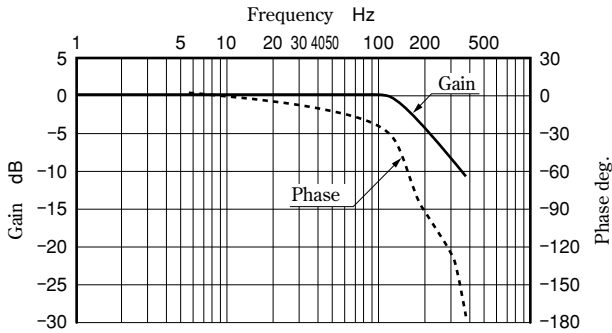

Amplifier : AMLS-A-D24- * -10 (Power Supply: 24 V DC)
Input Signal $\pm 25\%$

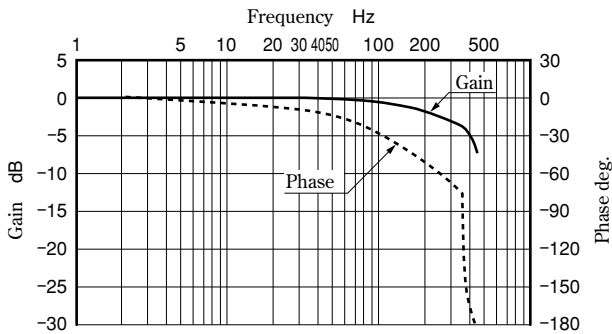

Input Signal $\pm 100\%$

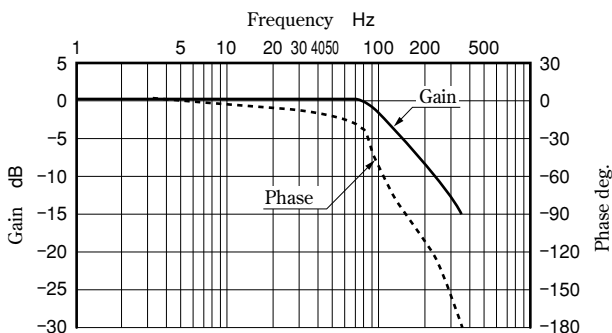

● LSVG-03-60-10

Amplifier : AMLS-B-D48- * -10 (Power Supply: 48 V DC)
Input Signal $\pm 25\%$

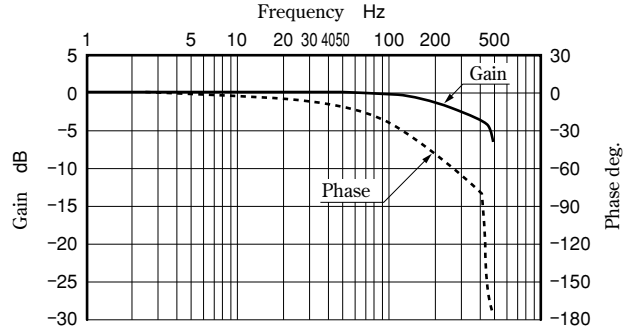

Input Signal $\pm 100\%$

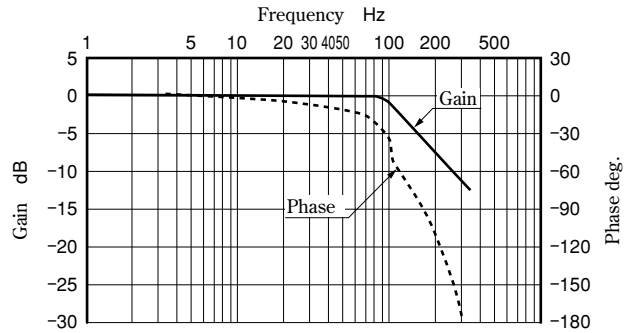

Amplifier : AMLS-B-D24- * -10 (Power Supply: 24 V DC)
Input Signal $\pm 25\%$

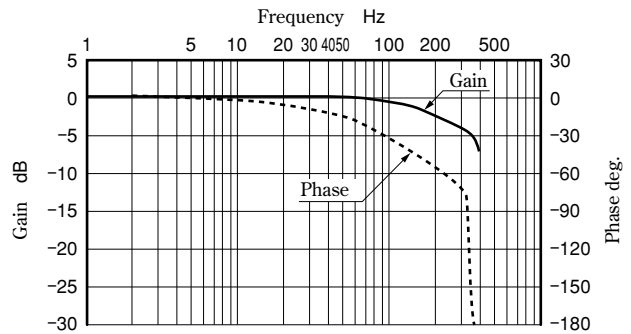

Input Signal $\pm 100\%$

